

MY26



JAC

60+ YEARS IN THE TRUCK GAME

7 YEAR WARRANTY
UNLIMITED, UNCOMPLICATED
INCLUDING COMMERCIAL USE*

JARA
JAC ALL ROADS ASSURANCE

ANCAP
SAFETY
TESTED 2024 ★★★★★

Please note: information is accurate as of October 2025. Specification and imagery are indicative and should only be used as a guide. Vehicle and accessory specification, features, colour and trim may differ at the time of vehicle delivery.



CONTENTS

- | | | |
|--------------------------------------|--------------------------|--------------------------|
| 3 Introduction | 7 Interior design | 15 Accessories |
| 4 60+ years in the truck game | 8 Safety | 16 Colours |
| 5 Exterior design | 12 Warranty | 22 Specifications |
| 6 Performance | 13 Tradies | 26 Disclaimers |



JAC STILL HOLDS THE TOP SPOT.

You'll find our vehicles in more than 130 countries and regions, now proudly including Australia. JAC is the #1 exporter of high-end light trucks and the #2 exporter of Utes from China, as at the end of 2025.

JAC has Research & Development facilities in three countries - Italy, Japan and China - and, in 2018, its relentless drive for improvement and innovation saw JAC become the first Chinese automotive brand to exceed 10,000 patents, including more than 1,750 invention patents. JAC currently holds more than 12,500 patents.



HARDEN THE TRUCK UP



WHEN YOU'VE BEEN BUILDING TRUCKS SINCE 1964, YOU GET TO KNOW A THING OR TWO ABOUT TOUGH.

The T9 has been put together by a team of the best automotive partners.



ENGINE CHAIN SYSTEM



BELT



EGR VALVE AND TRANSFER CASE



TURBO



BEARING BUSH



TRANSMISSION

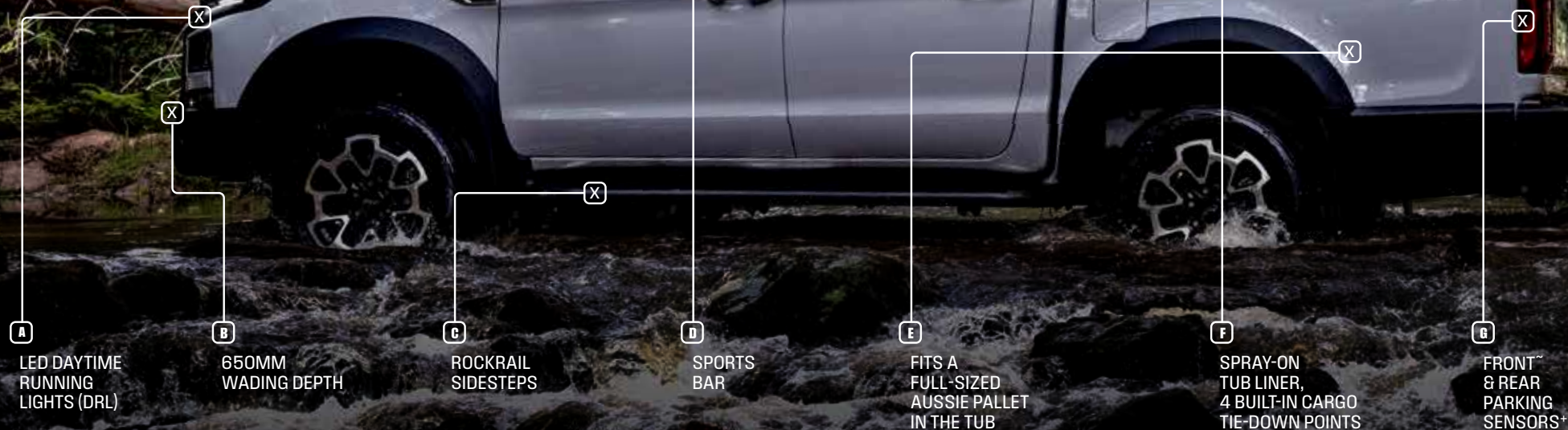

*Haven, Osprey & Osprey X models only
Haven shown

CITY ROADS, BACK ROADS, GREAT OPEN ROADS AND HARDLY-THERE ROADS

Whatever road you take, your JAC T9 is ready to rumble with 4X4 capability, and four driving modes that let you adjust to the conditions of the day. Switch to **SPORT**, **NORMAL**, **ECO** or **SNOW** in the blink of an eye.



**410Nm
TORQUE**



**4X4
REAR-DIFF LOCK**



**2.0L TURBO
DIESEL ENGINE**



**3200KG BRAKED
TOWING CAPACITY [02]**



**LEAF SPRING
RIGID AXLE REAR
SUSPENSION**



PAYLOAD [01]
Oasis, Haven: 1045KG
Osprey: 980KG
TradePro Cab-Chassis
& Oasis Cab-Chassis: 1165KG
(exc. weight of tray body)



KEY FEATURES

JAC T9 is locked and fully loaded, good to go wherever you want to go.



4X4 CAPABILITY: NORMAL, ECO, SPORT, SNOW



LEAF SPRING RIGID AXLE REAR SUSPENSION



REAR DIFF-LOCK



HILL DESCENT CONTROL & HILL-START HOLD CONTROL



650MM WADING DEPTH



PAYLOADS OASIS, HAVEN: 1045KG. OSPREY: 980KG. TRADEPRO CAB-CHASSIS & OASIS CAB-CHASSIS: 1165KG^[1]



FUEL TANK CAPACITY 76L



FUEL CONSUMPTION COMBINED 7.6L/100KM^[2]



3200KG BRAKED TOWING^[2]



320KG TOWBALL DOWNLOAD^{[2][3]}

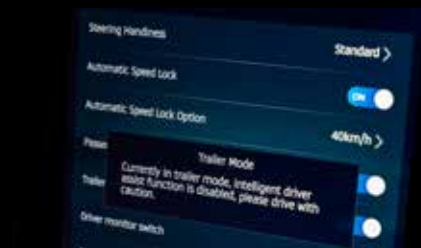

TRAILER MODE



360° CAMERA*

*Haven, Osprey & Osprey X models only
Haven shown

A WHOLE LOTTA LUXE IN THE CABIN

ALL THE EXTRA TRIMMINGS FOR THE TRADIE OFFICE.

Decked out with a lot of extra tech and extra luxe, it's every bit Business Class inside your JAC T9.

A
SOFT-TOUCH
MATERIALS

B
10.4-INCH TOUCHSCREEN
INFOTAINMENT UNIT

C
64-COLOUR LED-TAILORED
AMBIENT MOOD LIGHTING

D
WIRELESS
SMARTPHONE CHARGING

E
LARGE-STYLE EXECUTIVE
HEATED FRONT SEATING*

F
LEATHER ACCENTED
INTERIOR^[06]

*Haven, Osprey & Osprey X models only
Haven shown

KEY FEATURES

JAC T9 is locked and fully loaded, good to go wherever you want to go.



10.4 INCH INFOTAINMENT TOUCH-SCREEN WITH ANDROID AUTO[™] (07) & APPLE CARPLAY[™] (08)



7 INCH COLOUR INSTRUMENT CLUSTER



WIRELESS SMART PHONE CHARGING & USB-A



360° CAMERA^{*}



DAB+ RADIO



LEATHER ACCENTED INTERIOR⁽⁰⁶⁾



SPACIOUS BACKSEATS WITH A PERFECT 26 DEGREE RECLINE



HEATED FRONT SEATS^{*} & CLIMATE CONTROL



220V POWER PLUG^{*}, USB-A, AND USB-C IN THE BACK



CENTER CONSOLE COOLER BOX



64-COLOUR LED TAILORED AMBIENT MOOD LIGHTING SYSTEM



FRONT^{*} & BACK PARKING SENSORS

^{*}Haven, Osprey & Osprey X models only
Haven shown

AUSTRALIA'S SAFEST UTE

BASED ON THE AGGREGATED SCORES ACROSS ALL FOUR ANCAP 2024 PROTOCOLS.

LET THAT SINK IN - AUSTRALIA'S SAFEST UTE. NOT JUST SAFE. NOT JUST VERY SAFE. THE SAFEST.

The JAC T9 has achieved what many thought impossible for a newcomer: outperforming every single established Ute in the market in 2024, under ANCAP's most demanding safety protocols to date.



READ ANCAP SAFETY REPORT



KEY FEATURES

It's bumper-to-bumper safety with the ADAS (Advanced Driver Assistance System*) in your JAC T9, helping to protect you at every turn. Safety all round with 7 airbags, including a front centre airbag.

ACTIVE SAFETY+



AUTONOMOUS EMERGENCY BRAKING (AEB)



LANE DEPARTURE WARNING (LDW)



FORWARD COLLISION WARNING (FCW)



REAR COLLISION WARNING (RCW)



SPEED LIMIT ASSIST (SLA)



REAR AUTONOMOUS EMERGENCY BRAKING (R-AEB)



REAR CROSS TRAFFIC ALERT (RCTA)



TRAFFIC JAM ASSIST (TJA)



BLIND SPOT DETECTION (BSD)



ADAPTIVE CRUISE CONTROL (ACC)



DRIVER MONITORING SYSTEM (DMS)

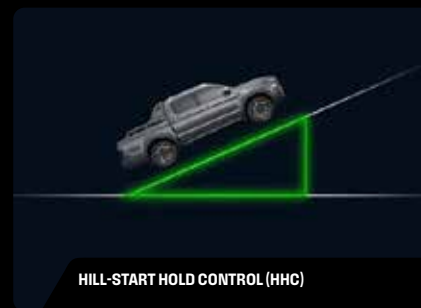

HILL-START HOLD CONTROL (HHC)

CLASS-LEADING PEACE OF MIND

JARA
JAC ALL ROADS ASSURANCE

7 YEAR WARRANTY
UNLIMITED, UNCOMPLICATED
INCLUDING COMMERCIAL USE*



NO MATTER WHO OWNS A JAC, WE'VE GOT YOUR BACK

We're here to support every JAC owner with JAC All Roads Assurance. No matter who you are, you'll get the same assurance. It's our 'no worries' way to keep you moving forward.

Your JAC comes fully loaded:

- 7-Year Warranty*. Unlimited KMs & Uncomplicated, including commercial use. Bumper-to-bumper.
- 7-Year Roadside Assistance* wherever you go, 24/7.
- 7-Year Capped Price Servicing* means no unwanted surprises.
- Access to JAC's industry-leading warranty 'Ute-for-Ute' loan vehicle program, built to keep you on the road, even when you're Ute's in the shop.^[09]
- Access to JAC-trained mechanics at every JAC dealership.
- Australia-based parts warehouse means less time waiting.

THE TUB THAT'S A BIG TICK FOR TRADIES

The JAC T9 can fit a full sized Aussie pallet in the tub. It comes with a spray-on protective tub liner, and 4 built-in cargo tie-down points, as standard across both models. Add to that a 1045kg payload^[D1] and it makes easy work of a day on the tools.

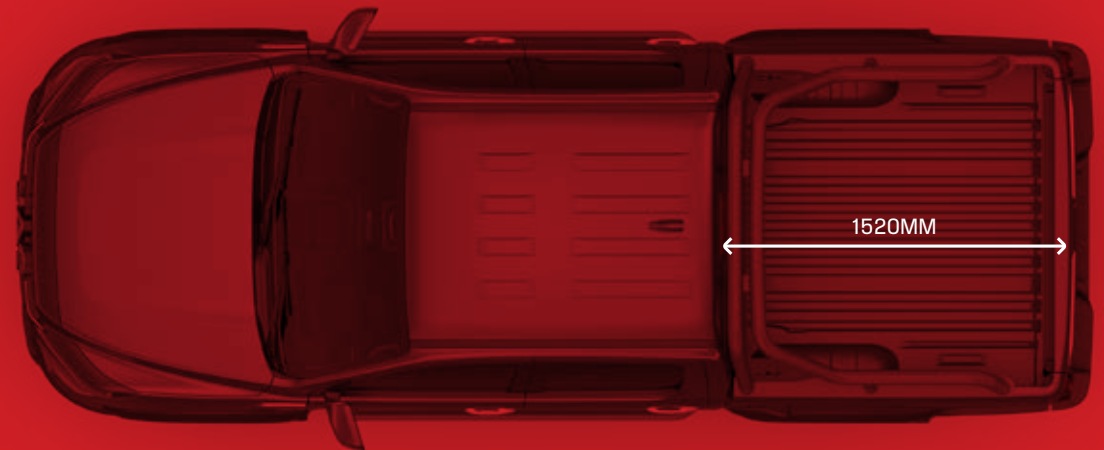
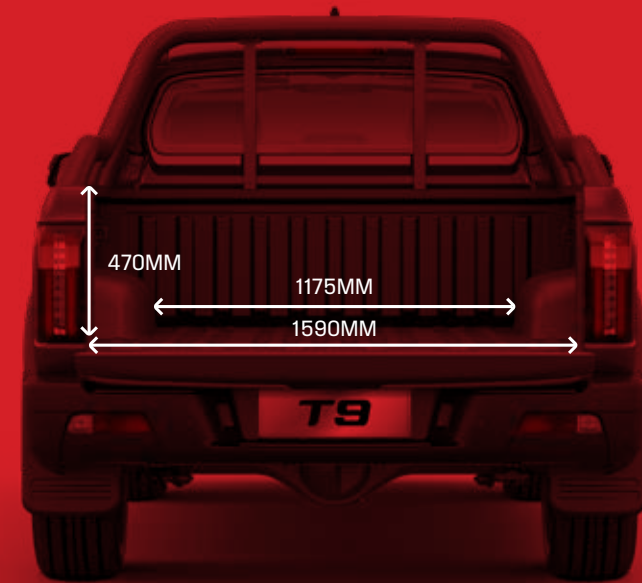

^[D1]Oasis, Haven, Osprey & Osprey X models only
Haven shown



NUDGE BAR



ROOF TRAY



LED LIGHT BAR

JAC GENUINE ACCESSORIES

JAC Genuine Accessories^[D12] are designed and tested right here in Australia to work perfectly with your T9 Ute. Every accessory is fitted by experts who know your vehicle inside and out, clicking together like they were made for each other (because they were).

No fuss, no guesswork - everything fits and performs exactly as it should. And they come with a 7-year warranty* when fitted at time of purchase by an authorised JAC Dealer.

- + CARPET FLOOR MATS (3 PIECE)
- + DEEP DISH FLOOR MATS (3 PIECE)
- + RUBBER TUB LINER MAT
- + DEEP DISH PLASTIC TUB MAT
- + WEATHER SHIELDS
- + BONNET PROTECTOR
- + TOWBAR
- + ELECTRONIC BRAKE CONTROLLER
- + NUDGE BAR
- + OUR PRODUCT RANGE WILL CONTINUE TO GROW.
- + ROOF TRAY
- + RIDGE MOUNTS
- + LADDER RACKS
- + SOFT STYLE TONNEAU COVER
- + SOFT STYLE CANOPY
- + MANUAL ROLL TOP COVER
- + ELECTRIC ROLL TOP COVER
- + HARD CANOPY
- + LED LIGHT BAR

EXTERIOR COLOURS.

STRATUS

KARAK ^[D11]

RED BELLY ^[D11]

HAMMERHEAD ^[D11]

HUNTSMAN ^[D11]

SALT BUSH ^[D11]

WREN ^[D11]

THE OASIS

LEATHER ACCENTED^[06] INTERIOR COLOUR: BLACK ON BLACK



THE HAVEN

LEATHER ACCENTED^[06] INTERIOR COLOUR: BLACK QUILTED



THE HAVEN

LEATHER ACCENTED^[06] INTERIOR COLOUR: BROWN QUILTED



THE T9'S EXCEPTIONAL RIDE HEIGHT OFFERS SUPERIOR ROAD VISIBILITY AND SPACIOUS COMFORT FOR ALL OCCUPANTS.

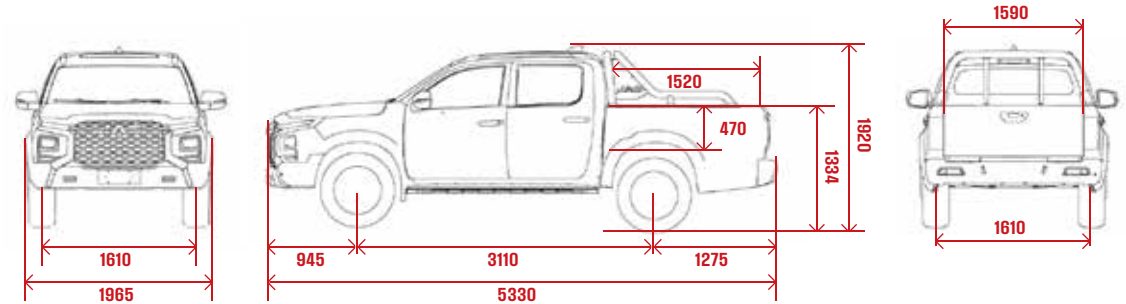

1920MM

5330MM

1965MM

1983MM WITH FOLDED MIRRORS
2186MM WITH MIRRORS EXTENDED

OVERALL DIMENSIONS (MM)	
Length	5330
Width (Mirrors Folded)	1983
Height	1920
TUB DIMENSIONS (MM)	
Length	1520
Width	1590
Height	470
GROSS COMBINATION MASS (GCM) (KG) ^[D12]	5630
GROSS VEHICLE MASS (GVM) (KG) ^[D12]	3100
KERB WEIGHT (KG)	2055
PAYLOAD (KG) ^[D1]	1045
TOWING CAPACITY ^[D2]	
Unbraked	750
Braked	3200
Maximum Towball Download	320

WHEELBASE (MM)	3110
APPROACH ANGLE (DEGREES)	27
DEPARTURE ANGLE (DEGREES)	23
WADING DEPTH (MM)	650
GROUND CLEARANCE (MM)	210

* OASIS, HAVEN, OSPREY & OSPREY X MODELS ONLY

OSPREY X 4X4 UTE



TICKS THE SALARY SACRIFICE BOX

It's engineered with all the muscle you need and loaded with design and tech features to make every drive feel good, from the power sunroof to the leather-accented interior and 360-degree camera.

POWER SUNROOF + BLACK EXTERIOR STYLING

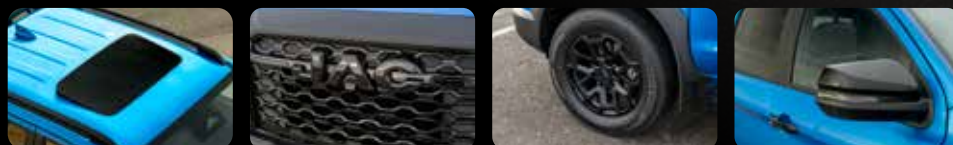

COLOUR OPTIONS

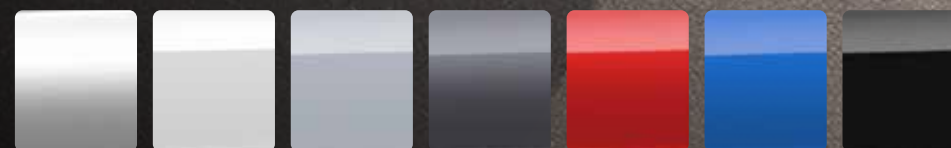

JAC T9 SPECS

OASIS
DOUBLE CAB PICKUP
2.0TD 4X4 AUTO

HAVEN
DOUBLE CAB PICKUP
2.0TD 4X4 AUTO

OSPREY
DOUBLE CAB PICKUP
2.0TD 4X4 AUTO

OSPREY X
DOUBLE CAB PICKUP
2.0TD 4X4 AUTO

OASIS CAB CHASSIS
DOUBLE CAB-CHASSIS
2.0TD 4X4 AUTO

TRADEPRO CAB CHASSIS
DOUBLE CAB-CHASSIS
2.0TD 4X4 AUTO

		OASIS DOUBLE CAB PICKUP 2.0TD 4X4 AUTO	HAVEN DOUBLE CAB PICKUP 2.0TD 4X4 AUTO	OSPREY DOUBLE CAB PICKUP 2.0TD 4X4 AUTO	OSPREY X DOUBLE CAB PICKUP 2.0TD 4X4 AUTO	OASIS CAB CHASSIS DOUBLE CAB-CHASSIS 2.0TD 4X4 AUTO	TRADEPRO CAB CHASSIS DOUBLE CAB-CHASSIS 2.0TD 4X4 AUTO
DIMENSIONS	Length/Width/Height (mm)	5330 / 1965 / 1920	5330 / 1965 / 1920	5330 / 1965 / 1920	5330 / 1965 / 1920	5330 / 1965 / 1920	5330 / 1965 / 1920
	Body Width With Door Mirrors Folded (mm)	1983	1983	1983	1983	1983	1983
	Tray/tub Dimension (mm)	1520 / 1590 / 470	1520 / 1590 / 470	1520 / 1590 / 470	1520 / 1590 / 470	—	—
	Wheelbase (mm)	3110	3110	3110	3110	3110	3110
	Min Ground Clearance (mm)	210	210	210	210	210	210
	Min. Turning Radius (m)	6.5	6.5	6.5	6.5	6.5	6.5
	Approach angle	27	27	27	27/23	27	27
	Departure angle	23	23	23	23	23	23
Wading Depth (mm)	650	650	650	650	650	650	
ENGINE	Fuel Type	Diesel	Diesel	Diesel	Diesel	Diesel	Diesel
	Displacement (cc)	1999	1999	1999	1999	1999	1999
	Max Power (kW/r/min)	125/3600	125/3600	125/3600	125/3600	125/3600	125/3600
	Max Torque (Nm/r/min)	410/1500-2500	410/1500-2500	410/1500-2500	410/1500-2500	410/1500-2500	410/1500-2500
	Fuel Tank Capacity (L)	76	76	76	76	76	76
	Combined Fuel Economy (L/100km) ^[02]	7.6	7.6	7.6	7.6	7.6	7.6
	CO2 Emissions (g/km) combined	202	202	202	202	202	202
	Transmission	8AT	8AT	8AT	8AT	8AT	8AT
	Emission Standard	Euro V	Euro V	Euro V	Euro V	Euro V	Euro V
Net Power (kW @ r/min)	120/3600	120/3600	120/3600	120/3600	120/3600	120/3600	
TRANSMISSION	Transmission Model	8HP50	8HP50	8HP50	8HP50	8HP50	8HP50
	Part-time 4WD System	•	•	•	•	•	•
	Drive Mode Switch(Normal/ECO/Sport/Snow)	•	•	•	•	•	•
PERFORMANCE	Max Speed (km/h)	150	150	150	150	150	150
	Max Gradeability (%)	30	30	30	30	30	30
WEIGHTS AND CAPABILITIES	GVW (kg) ^[02]	3100	3100	3050	3050	3100	3100
	Kerb Weight (kg)	2055	2055	2070	2070	1935 (exclude weight of tray body)	1935 (exclude weight of tray body)
	Payload (kg) ^[01]	1045	1045	980	980	1165 (exclude weight of tray body)	1165 (exclude weight of tray body)
	Braked Towing Capacity (kg) ^[02]	3200	3200	3200	3200	3200	3200
	Unbraked Towing Capacity (kg) ^[02]	750	750	750	750	750	750
	Maximum Tow Ball download (kg) ^[02]	320	320	320	320	320	320
Gross Combination Mass (GCM) (kg) ^[02]	5630	5630	5630	5630	5630	5630	
CHASSIS & STEERING	Double Wishbone Independent Suspension With Coil Spring	•	•	•	•	•	•
	Non-independent Leaf Spring Rigid Axle Rear Suspension	•	•	•	•	•	•
	Number Of Leaf Springs	3+2	3+2	3+2	3+2	3+2	3+2
	Rear Axle Electronic Differential Lock	•	•	•	•	•	•
	Electronic Power Steering	•	•	•	•	•	•
	Front Brake	Disc	Disc	Disc	Disc	Disc	Disc
	Rear Brake	Disc	Disc	Disc	Disc	Disc	Disc
	Electronic Parking Brake	•	•	•	•	•	•
Auto Hold	•	•	•	•	•	•	
WHEELS & TYPES	Tire Size	265/60R18	265/60R18	265/60R18	265/60R18	265/60R18	265/60R18
	Wheel Tread (GitiHT)	•	•	•	•	•	•
	Steel Rim	—	—	—	—	—	• (Silver)
	Aluminium Alloy Rim	•	•	•	• (Black)	•	—
	Spare Tire With Steel Rim	•	•	•	•	•	•
	Spare Tire Type	265/60R18	265/60R18	265/60R18	265/60R18	265/60R18	265/60R18

JAC T9 SPECS

		OASIS DOUBLE CAB PICKUP 2.0TD 4X4 AUTO	HAVEN DOUBLE CAB PICKUP 2.0TD 4X4 AUTO	OSPREY DOUBLE CAB PICKUP 2.0TD 4X4 AUTO	OSPREY X DOUBLE CAB PICKUP 2.0TD 4X4 AUTO	OASIS CAB CHASSIS DOUBLE CAB-CHASSIS 2.0TD 4X4 AUTO	TRADEPRO CAB CHASSIS DOUBLE CAB-CHASSIS 2.0TD 4X4 AUTO
SAFETY & SECURITY	Anti-Lock Braking System (ABS)	•	•	•	•	•	•
	Electronic Brake-Force Distribution (EBD)	•	•	•	•	•	•
	Brake Override System (BOS)	•	•	•	•	•	•
	Hill-start Hold Control(HHC)	•	•	•	•	•	•
	Hydraulic Brake Assist (HBA)	•	•	•	•	•	•
	Traction Control System(TCS)	•	•	•	•	•	•
	Vehicle Dynamics Control(VDC)	•	•	•	•	•	•
	Electronic Stability Control(ESC)	•	•	•	•	•	•
	Tyre Pressure Monitoring System (TPMS)	•	•	•	•	•	•
	Driver And Front Passenger Airbags	•	•	•	•	•	•
	Front Centre Airbag	•	•	•	•	•	•
	Driver and Front Passenger Side Airbags	•	•	•	•	•	•
	Side Curtain Airbags	•	•	•	•	•	•
	Height-adjustable front seatbelts	•	•	•	•	•	•
	Front Seatbelt Pre- tensioners	•	•	•	•	•	•
	3-point seatbelts for Rear Outboard Seats	•	•	•	•	•	•
	3-point seatbelt for Rear Center Seat	•	•	•	•	•	•
	Rear Center Seat Headrest	•	•	•	•	•	•
	Power Door Lock	•	•	•	•	•	•
	Remote Central Locking	•	•	•	•	•	•
Smart Keyless Entry With Push Button Start	•	•	•	•	•	•	
Central Locking Rear Tailgate	•	•	•	•	•	•	
Engine Immobiliser	•	•	•	•	•	•	
ISOFIX On Rear Outboard Seats	•	•	•	•	•	•	
Child Safety Lock	•	•	•	•	•	•	
DRIVER ASSISTANCE	Hill Descent Control (HDC)	•	•	•	•	•	•
	Lane Departure Warning (LDW)	•	•	•	•	•	•
	Lane Keeping Assist (LKA)	•	•	•	•	•	•
	Emergency Lane Keeping (ELK)	•	•	•	•	•	•
	Blind Spot Detection (BSD)	•	•	•	•	•	•
	Lane Change Assist (LCA)	•	•	•	•	•	•
	Rear Cross Traffic Alert (RCTA)	•	•	•	•	•	•
	Forward Collision Warning (FCW)	•	•	•	•	•	•
	Rear Collision Warning (RCW)	•	•	•	•	•	•
	Door Open Warning (DOW)	•	•	•	•	•	•
	Speed Limit Assist (SLA)	•	•	•	•	•	•
	Traffic Sign Recognition (TSR)	•	•	•	•	•	•
	Traffic Jam Assistant (TJA)	•	•	•	•	•	•
	Driver Monitor System (DMS)	•	•	•	•	•	•
	Autonomous Emergency Braking (AEB)	•	•	•	•	•	•
	Rear-Autonomous Emergency Braking (R-AEB)	•	•	•	•	•	•
	Adaptive Cruise Control (ACC)	•	•	•	•	•	•
	Integrated Cruise Assist (ICA)	•	•	•	•	•	•
	Intelligence High Beam Control (IHBC)	•	•	•	•	•	•
	Front Parking Sensors	—	•	•	•	—	—
Rear Parking Sensors	•	•	•	•	•	•	
Reversing Camera	•	—	—	—	•	•	
360° View Camera	—	•	•	•	—	—	

JAC T9 SPECS

		OASIS DOUBLE CAB PICKUP 2.0TD 4X4 AUTO	HAVEN DOUBLE CAB PICKUP 2.0TD 4X4 AUTO	OSPREY DOUBLE CAB PICKUP 2.0TD 4X4 AUTO	OSPREY X DOUBLE CAB PICKUP 2.0TD 4X4 AUTO	OASIS CAB CHASSIS DOUBLE CAB-CHASSIS 2.0TD 4X4 AUTO	TRADEPRO CAB CHASSIS DOUBLE CAB-CHASSIS 2.0TD 4X4 AUTO
TUB	Standard Tub	•	•	•	•	—	—
	Spray-In Bedliner	•	•	•	•	—	—
	Black Metal Roll Bar	•	•	•	•	—	—
	Tub Cargo Tie Down Hooks	• (4)	• (4)	• (4)	• (4)	—	—
EXTERIOR	Black JAC Logo on Grille	◦	◦	◦	•	◦	◦
	Chrome JAC Logo on Grille	•	•	•	—	•	•
	Steel Side Steps	•	•	•	•	•	•
	Body-Colored Exterior Mirrors	•	—	—	—	•	•
	Chrome Exterior Mirrors	—	•	•	—	—	—
	Black Exterior Mirrors	—	—	—	•	—	—
	Power Adjustable Exterior Mirrors	•	•	•	•	•	•
	Heated Exterior Mirrors	•	•	•	•	•	•
	Power Folding Exterior Mirrors	—	•	•	•	—	—
	Bright Black Door Handle	—	—	—	•	—	—
	Chrome Door Handle	•	•	•	—	•	•
	Black Roof Rails	—	—	—	•	—	—
	Silver Roof Rails	—	• ^[015]	•	—	—	—
	Roof Trim ^[014]	—	•	—	—	—	—
	Power Sunroof	—	—	•	•	—	—
Rear Privacy Glass	—	•	•	•	—	—	
LIGHTS	LED Headlights	•	•	•	•	•	•
	LED Daytime Running Light	•	•	•	•	•	•
	LED Tail Light	•	•	•	•	•	•
	High-Mounted Brake Light	•	•	•	•	•	•
	Front Fog Light	•	•	•	•	•	•
	Rear Fog Light	•	•	•	•	•	•
	Adjustable Headlights Height	•	•	•	•	•	•
	Auto Headlight	•	•	•	•	•	•
	Follow-Me-Home Headlights	•	•	•	•	•	•
Welcome Puddle Lights	—	•	•	•	—	—	
SEATING	Leather Accented Seats ^[006]	•	•	•	•	•	—
	Fabric Seats	—	—	—	—	—	•
	Power Driver's Seat Adjustment	6-Way	6-Way	6-Way	6-Way	6-Way	6-Way
	Manual Front Passenger's Seat Adjustment	6-Way	—	—	—	6-Way	6-Way
	Power Front Passenger's Seat Adjustment	—	4-Way	4-Way	4-Way	—	—
	60:40 Folding 2nd Row Seats	•	•	•	•	•	•
	Heated Front Seats	—	•	•	•	—	—

^[014] THE 10TH DIGIT OF THE VIN IS 'P' OR 'R', THESE VEHICLES ARE FITTED WITH ROOF TRIMS AND HAVE NO LOAD CARRYING CAPACITY

^[015] THE 10TH DIGIT OF THE VIN IS ANY LETTER FROM 'S' TO 'Z' (INCLUSIVE), THESE VEHICLES ARE FITTED WITH ROOF RAILS AND HAVE A MAXIMUM LOAD CAPACITY OF 80KG

JAC T9 SPECS

OASIS
DOUBLE CAB PICKUP
2.0TD 4X4 AUTO

HAVEN
DOUBLE CAB PICKUP
2.0TD 4X4 AUTO

OSPREY
DOUBLE CAB PICKUP
2.0TD 4X4 AUTO

OSPREY X
DOUBLE CAB PICKUP
2.0TD 4X4 AUTO

OASIS CAB CHASSIS
DOUBLE CAB-CHASSIS
2.0TD 4X4 AUTO

TRADEPRO CAB CHASSIS
DOUBLE CAB-CHASSIS
2.0TD 4X4 AUTO

	OASIS DOUBLE CAB PICKUP 2.0TD 4X4 AUTO	HAVEN DOUBLE CAB PICKUP 2.0TD 4X4 AUTO	OSPREY DOUBLE CAB PICKUP 2.0TD 4X4 AUTO	OSPREY X DOUBLE CAB PICKUP 2.0TD 4X4 AUTO	OASIS CAB CHASSIS DOUBLE CAB-CHASSIS 2.0TD 4X4 AUTO	TRADEPRO CAB CHASSIS DOUBLE CAB-CHASSIS 2.0TD 4X4 AUTO
INTERIOR	Ambient Lights (Instrument Panel)	•	•	•	•	•
	Black Interior	• (Light Grey Roof Lining)	• (Black Roof Lining)	• (Black Roof Lining)	• (Black Roof Lining)	• (Black Roof Lining)
	Leather Accented Interior ⁽⁰⁶⁾	•	•	•	•	•
	Black Or Brown Leather Accented Interior	—	◦ (Black Roof Lining)	◦ (Black Roof Lining)	◦ (Black Roof Lining)	—
	Front Reading Light	•	•	•	•	•
	Rear Reading Light	•	•	•	•	•
	Sunglass Holder	•	•	•	•	•
	Driver And Front Passenger Sun visors	•	•	•	•	•
	Front Passenger Sun Visor With Vanity Mirror	•	•	•	•	•
	Plastic Steering Wheel	—	—	—	—	•
	Leather Bound Steering Wheel	•	•	•	•	—
	Multi-Functional Steering Wheel	•	•	•	•	•
	Steering Wheel Tilt Adjustment	•	•	•	•	•
	B-Pillar Grab Handle	•	•	•	•	•
	Power Window	•	•	•	•	•
	Remote Control of Opening/Closing Windows	•	•	•	•	•
	Automatic Up/Down + Anti-Clamp For All Windows	•	•	•	•	•
	Manual Anti-glare Of Interior Mirror	•	—	—	—	•
	Automatic Anti-glare Of Interior Mirror	—	•	•	•	—
	Rain Sensing Windscreen Wipers	•	•	•	•	•
Automatic Air Conditioning	•	•	•	•	•	
Rear Armrest With Cup Holders	•	•	•	•	•	
AUDIO & COMMUNICATION	7" Colour Instrument Cluster	•	•	•	•	•
	DAB+ Digital Radio	•	•	•	•	•
	Bluetooth Connectivity	•	•	•	•	•
	10.4" Touch Screen Infotainment Display	•	•	•	•	•
	Wired Apple CarPlay [®] ⁽⁰⁶⁾ / Android Auto [™] ⁽⁰⁷⁾	•	•	•	•	•
	Smartphone Connectivity	•	•	•	•	•
	Speakers	6	6	6	6	6
	Front USB Ports	2	2	2	2	2
	Front 12V Power Outlet	•	•	•	•	•
	Wireless Phone Charging	•	•	•	•	•
	Rear USB Port	•	•	•	•	•
	Rear Type-C Port	—	•	•	•	—
Rear 220V Power Outlet	—	•	•	•	—	

DISCLAIMERS

* DRIVER ASSISTANCE SYSTEMS WORK ONLY WITHIN SYSTEM LIMITS AND ARE INTENDED TO ASSIST THE DRIVER. THE DRIVER REMAINS RESPONSIBLE FOR DRIVING THE VEHICLE AND IS REQUIRED TO REMAIN ATTENTIVE AT ALL TIMES. CHECK YOUR OWNER'S MANUAL FOR EXPLANATION OF LIMITATIONS. PLEASE DRIVE SAFELY.

^ 7-YEAR MANUFACTURER'S WARRANTY FROM THE DATE OF FIRST REGISTRATION. TERMS, CONDITIONS AND EXCLUSIONS APPLY. SEE JACUTE.COM.AU.

[D1] PAYLOAD IS THE GVM MINUS THE KERB MASS. THE KERB MASS DOES NOT INCLUDE PASSENGERS, LUGGAGE, CARGO, ANY ACCESSORIES FITTED OR ANY TOWBALL DOWNLOAD (AS APPROPRIATE). PAYLOAD IS DISTRIBUTED ACROSS BOTH THE FRONT AND REAR AXLES; NEVER EXCEED THE GVM OR THE AXLE LIMITS.

[D2] TOWING CAPACITY SUBJECT TO REGULATORY REQUIREMENTS, AND VEHICLE EQUIPMENT DESIGN LIMITATIONS. SPEAK WITH YOUR AUTHORISED JAC DEALER FOR MORE INFORMATION.

[D3] FUEL CONSUMPTION RESULTS ACHIEVED IN ADR81/02 FUEL CONSUMPTION TESTING. RESULTS PRODUCED IN LABORATORY TEST CONDITIONS, USING SAMPLE VEHICLES WITHOUT FITMENT OF ACCESSORIES/CUSTOMISATION, AND DO NOT REFLECT REAL WORLD DRIVING. FIGURES SHOULD ONLY BE USED FOR COMPARATIVE PURPOSES.

[D4] TOW BALL, TONGUE AND WIRING HARNESS SOLD SEPARATELY.

[D5] OPTIONAL DEALER FITTED ACCESSORY. SPEAK WITH YOUR AUTHORISED JAC DEALER FOR MORE INFORMATION.

[D6] LEATHER ACCENTED FEATURES AND UPHOLSTERY MAY CONTAIN SYNTHETIC MATERIAL.

[D7] ANDROID AUTO™ IS A TRADEMARK OF GOOGLE LLC.

[D8] CARPLAY™ IS A TRADEMARK OF APPLE, INC. REGISTERED IN THE U.S. AND OTHER COUNTRIES.

[D9] TERMS AND CONDITIONS APPLY. PLEASE VISIT WWW.CARBIZ.COM.AU FOR FULL DETAILS.

[D10] SEE YOUR JAC MOTORS DEALERSHIP TO CONFIRM WHICH GENUINE ACCESSORY IS SUITABLE FOR YOUR VEHICLE PRIOR TO ORDERING, AS SPECIFICATIONS, APPLICABILITY, AVAILABILITY AND FITMENT REQUIREMENTS MAY CHANGE OVER TIME. CONSIDER COMBINED MASS OF LOAD AND ACCESSORIES TO ENSURE GROSS VEHICLE MASS LIMITS ARE NOT EXCEEDED.

[D11] OPTIONAL METALLIC PAINT AT ADDITIONAL COST.

[D12] WEIGHTS/MASS/VOLUMES/DIMENSIONS ARE APPROXIMATE AND SUBJECT TO INDIVIDUAL VEHICLE VARIANCES, AND SHOULD BE CONFIRMED BEFORE FITTING ANY ACCESSORIES, TOWING OR OTHERWISE RELYING ON THIS VALUE.

[D13] BLUETOOTH® IS A REGISTERED TRADEMARK OF BLUETOOTH SIG, INC.

[D14] THE 10TH DIGIT OF THE VIN IS 'P' OR 'R', THESE VEHICLES ARE FITTED WITH ROOF TRIMS AND HAVE NO LOAD CARRYING CAPACITY

[D15] THE 10TH DIGIT OF THE VIN IS ANY LETTER FROM 'S' TO 'Z' (INCLUSIVE), THESE VEHICLES ARE FITTED WITH ROOF RAILS AND HAVE A MAXIMUM LOAD CAPACITY OF 80KG

IMPORTANT NOTICE - JAC AUTO (PICKUP) ENSURES THE MATERIAL IS ACCURATE AT THE TIME OF PUBLISHING. ALL INFORMATION MUST BE CONFIRMED WITH YOUR JAC MOTORS DEALER AT THE TIME OF ORDERING, AS SPECIFICATIONS, APPLICABILITY AND AVAILABILITY MAY CHANGE OVER TIME.

JAC AUTO (PICKUP) RESERVES THE RIGHT TO CHANGE AND/OR DISCONTINUE, WITHOUT NOTICE, MODELS, PRICES, COLOURS, MATERIALS, EQUIPMENT, SPECIFICATIONS TO THE EXTENT PERMITTED BY LAW. JAC AUTO (PICKUP) WILL NOT BE LIABLE FOR ANY DAMAGE OR LOSS INCURRED FROM RELYING ON THE INFORMATION AND IMAGES CONTAINED IN THIS MATERIAL.



JAC

— THE JAC OF ALL TRADES —

BOOK A TEST DRIVE

